

# 4MP LightHunter Intelligent Vandal-resistant Dome Network Camera

IPC3234SA-DZK

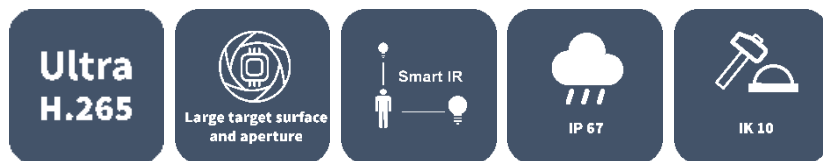

## Key Features



## Optics

- 1/1.8", Powered by lighthunter
- Smart IR, up to 40m (131 ft) IR distance
- Up to 120 dB Optical WDR (Wide Dynamic Range)

## Compression

- Ultra 265, H.265, H.264, MJPEG
- Five streams
- 2688\*1520@30fps in the main stream
- ROI (Region of Interest)

## Network

- ONVIF Conformance

## Structure

- DC12V or AC24V or PoE power supply
- Wide voltage range of  $\pm 25\%$  in AC,  $\pm 25\%$  in DC

- Micro SD, up to 256 GB
- Alarm 1 in and 1 out, Audio 1 in and 1 out
- IP67 ingress protection
- IK10 vandal resistant

## Specifications

IPC3234SA-DZK					
<b>Camera</b>					
Sensor	1/1.8", 4.0 megapixel, progressive scan, CMOS				
Lens	2.8-12mm@F1.2, AF automatic focusing and motorized zoom lens				
Iris	Auto aperture				
DORI Distance	Lens (mm)	Detect (m)	Observe (m)	Recognize (m)	Identify (m)
	2.8	42(137.8ft)	16.8(55.1ft)	8.4(27.6ft)	4.2(13.8ft)
	12	180(590.4ft)	72(236.2ft)	36(118.1ft)	18(59.0ft)
Angle of View (H)	35.6°~107.9°				
Angle of View (V)	20.4°~75.4°				
Angle of View (O)	43.8°~140.3°				
Shutter	Auto/Manual, 1 ~ 1/100000s				
Adjustment angle	Pan: 0°~355°		Tilt: 0°~68°		Rotate: 0°~355
Min. Illumination	Colour:0.0005lux (F1.2, AGC ON) 0 lux with IR				
WDR	120dB				
Day/Night	IR-cut filter with auto switch (ICR)				
S/N	>55dB				
IR Range	Up to 40m (131 ft) IR range				
Wavelength	850nm				
IR On/Off Control	Auto/Manual				
Defog	Digital Defog				
<b>Video</b>					
Video Compression	Ultra 265, H.265, H.264, MJPEG				
Frame Rate	Main Stream: 4MP(2688*1520),Max 30fps; 4MP(2560*1440),Max 30fps; 2MP(1920*1080),Max 60fps Sub Stream: 2MP (1920*1080), Max 60fps; Third Stream: D1 (720*576), Max 60fps Fourth Stream: D1 (720*576), Max 60fps Fifth Stream: D1 (720*576), Max 60fps				
Video Bit Rate	128 Kbps~16 Mbps				
ROI	Supported				
Video stream	Five streams				
OSD	Up to 8 OSDs				
Privacy Mask	Up to 8 areas (8 blacks / 8 mosaics)				
<b>Image</b>					
White Balance	Auto/Outdoor/Fine Tune/Sodium Lamp/Locked/Auto2				
Digital noise reduction	2D/3D DNR				
Smart IR	Support				
Flip	Normal/Flip Vertical/Flip Horizontal/180°/90°Clockwise/90°Anti-clockwise				
HLC	Support				
BLC	Support				

Smart	
General Function	Watermark, IP Address Filtering, Tampering Alarm, Alarm input, Alarm output, Access Policy, ARP Protection, RTSP Authentication, User Authentication
Audio	
Audio Compression	G.711U,G.711A
Two way audio	Supported
Sampling Rate	8KHZ
Storage	
Edge Storage	Micro SD, up to 256 GB
Network Storage	ANR,NAS(NFS)
Network	
Protocols	IPv4, IGMP, ICMP, ARP, TCP, UDP, DHCP, PPPoE, RTP, RTSP, RTCP, DNS, DDNS, NTP, FTP, UPnP, HTTP, HTTPS, SMTP, 802.1x, SNMP, QoS, RTMP
Compatible Integration	ONVIF, API
Client	EZStation Ezview EZLive
Web Browser	Plug-in required live view: IE9+, Chrome 41 and below, Firefox 52 and below
Interface	
Audio I/O	Audio cable
	1 Input: impedance 35kΩ; amplitude 2V [p-p]
	1 output: impedance 600Ω; amplitude 2V [p-p]
Alarm I/O	1/1
Network	1 x RJ45 10M/100M Base-TX Ethernet
Certifications	
Certifications	CE: EN 60950-1 UL: UL60950-1 FCC: FCC Part 15
General	
Power	AC24V±25%, DC12V(±25%), PoE(IEEE 802.3af)
	Power consumption: Max 10W
	Support overcurrent protection , Input short circuit protection
Dimensions (∅ x H)	∅148 x 111.3mm(∅5.8" x 4.4")
Net Weight	0.96kg(2.12lb)
Material	Metal
Working Environment	-30°C~60°C(-22°F ~ 140°F), Humidity: ≤95% RH (non-condensing)
Storage Environment	-40°C~70°C(-40°F ~ 158°F), Humidity: ≤95% RH (non-condensing)
Surge protection	6KV
Vandal Resistant	IK10
Ingress Protection	IP67

## Dimensions

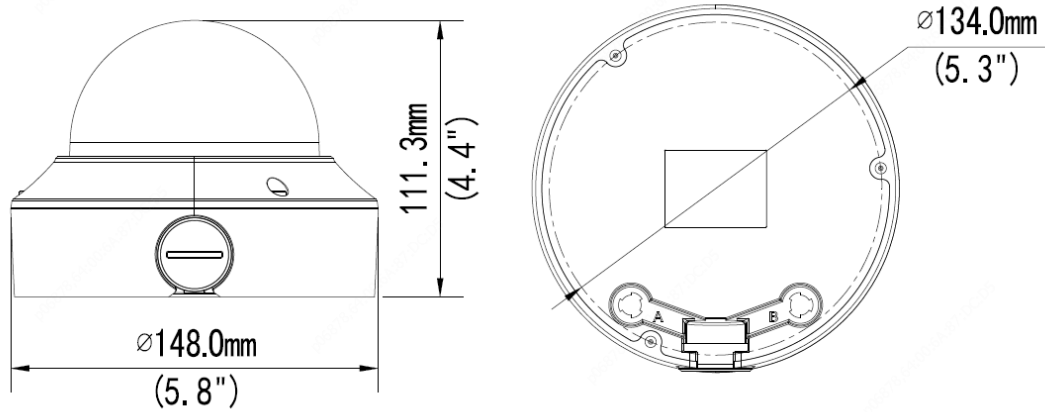

## Accessories

TR-JB04-C-IN



TR-JB07/WM04-B-IN



TR-WM04-IN



TR-FM152-A-IN



TR-SM04-IN



TR-A01-IN



TR-UP06-IN



TR-SE24-IN



TR-SE24-A-IN



TR-CM24-IN



### Junction Mount

TR-JB04-C-IN+ TR-A01-IN

### Pole Mount

TR-JB07/WM04-B-IN、 TR-WM04-IN+TR-UP06-IN

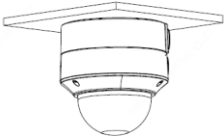
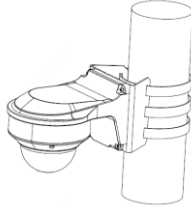
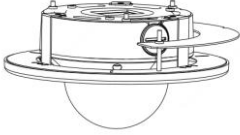
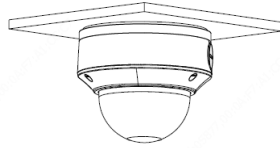
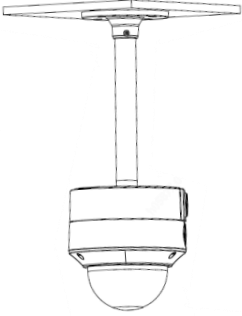
	
<p>In-celling mount</p>	<p>Electric-box Transfer plate</p>
<p>TR-FM152-A-IN</p>	<p>TR-SM04-IN</p>
	
<p>Indoor pendent mount</p>	
<p>TR-JB04-C-IN + TR-SE24-IN/TR-SE24-A-IN + TR-CM24-IN</p>	
	

**Zhejiang Uniview Technologies Co., Ltd.**

Building No.10, Wanlun Science Park, Jiangling Road 88, Binjiang District, Hangzhou, Zhejiang, China (310051)

Email: [overseasbusiness@uniview.com](mailto:overseasbusiness@uniview.com); [globalsupport@uniview.com](mailto:globalsupport@uniview.com)

<http://www.uniview.com>

©2020 Zhejiang Uniview Technologies Co., Ltd. All rights reserved.

\*Product specifications and availability are subject to change without notice